

37ª EDIÇÃO

BAJA PORTALEGRE 2023

500

AUTOMÓVEL CLUB DE PORTUGAL



MINI BAJA
MAPAS
ROAD BOOK LIGAÇÕES
ROAD BOOK ASSISTÊNCIA
PLANO DE ABASTECIMENTO
OUTROS

26 A 28 OUTUBRO

2023

TAÇA DO MUNDO FIA DE BAJAS • CAMPEONATO DE PORTUGAL DE TODO O TERRENO FPAK
CLASSIC TT • CAMPEONATO NACIONAL DE TODO O TERRENO OPEN FMP • MINI BAJA

BAJAPORTALEGRE500.COM



Nos circuitos do dia a dia, a bp compensa.

Quando está em prova, o Miguel sabe quantas voltas tem de dar. No dia a dia, quem decide o número de voltas é a sua filha. Às vezes adormece logo na primeira, outras vezes, são precisas muitas mais. Mas em todas, o Miguel sabe que a bp compensa. Compensa pela poupança com os cartões de fidelização da bp e compensa pelos quilómetros extra*, obtidos através do uso de combustíveis bp Ultimate com tecnologia ACTIVE. Nos circuitos do dia a dia, a bp compensa e o Miguel aproveita.

O melhor, todos os dias



*Gasóleo bp Ultimate com tecnologia ACTIVE, garante até 56 km extra por depósito. Testado em comparação com combustíveis em conformidade com as especificações definidas pela legislação em vigor. Os benefícios anunciados verificam-se em utilizações continuadas e podem variar de acordo com o estado do veículo, estilo de condução ou outros fatores. Saiba mais em bp.pt

37ª EDIÇÃO

BAJA PORTALEGRE 2023

500

AUTOMÓVEL CLUB DE PORTUGAL



CERIMONIAL START
CERIMÓNIA DE PARTIDA

26-10-2023



Layout
Service Park 2023
V2 07.09.2023

- 1- Entrada principal veículos e peões / main entrance and pedestrian entrance
- 2- Entrada de veículos de competição / entrance competitors only / saída-exit
- 3- Entrada exclusiva a peões / entrance for pedestrians only

P Reboques
 Trailers

P Media
 Organização /
 Organiser



Para / To
 Portalegre
 Gasolinheiras / Gas stations
 Cerimónia de Partida / Ceremonial Start
 SS3 Auto
 SS3 Moto / Quad / SSV
 SS2 Moto / Quad / SSV (Hobby)

- a TC CS1; TC 2D; TC 3D (só / only auto); TC 4B e TC 3C (só / only Auto)
- b TC 0; TC 2E; TC 3E
- c TC 2B; TC 3B c1 TC 2Aa ; TC 3Aa
- d TC 2C (só / only Auto)
- e TC 3C (só / only Auto)
- f TC V1
- g TC V2
- h TC V3

Para / To
 Arnonches
 Espanha / Spain
 Gasolinheiras / Gas stations
 Partida / Start
 SS 1 & SS2 (Auto / Moto)

De / From
 Chegada / Arrival
 SS 1 (Promoção Baja & Hobby)
 SS2 Moto & Auto / Cars
 SS3 & SS4 Auto / Cars
 SS3 Moto / Bike

Rua do Ardina

Azinhaga Frazoa

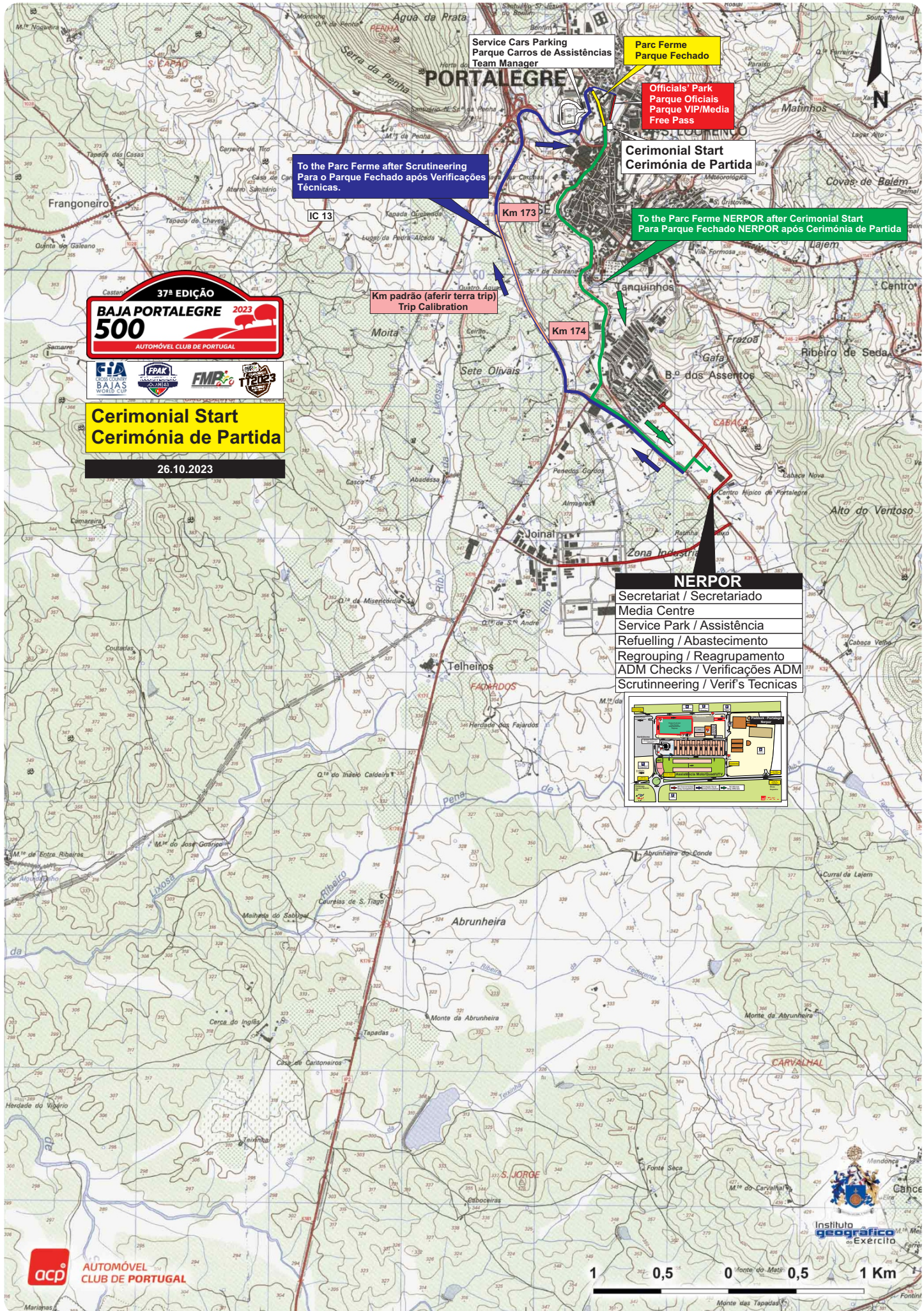

Service Cars Parking
Parque Carros de Assistências
Team Manager

Parc Ferme
Parque Fechado

Officials' Park
Parque VIP/Media
Free Pass

Cerimonial Start
Cerimónia de Partida

To the Parc Ferme after Scrutinering
Para o Parque Fechado após Verificações
Técnicas.

To the Parc Ferme NERPOR after Cerimonial Start
Para Parque Fechado NERPOR após Cerimónia de Partida

Km padrão (aferir terra trip)
Trip Calibration

Km 174

37ª EDIÇÃO
BAJA PORTALEGRE 2023
500
AUTOMÓVEL CLUB DE PORTUGAL



Cerimonial Start
Cerimónia de Partida

26.10.2023

NERPOR

Secretariat / Secretariado
Media Centre
Service Park / Assistência
Refuelling / Abastecimento
Regrouping / Reagrupamento
ADM Checks / Verificações ADM
Scrutinering / Verif's Tecnicas

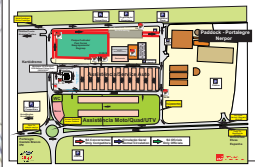



**Cerimonial Start
Cerimónia de Partida**
26.10.2023



PARKING/PARQUE:
TEAM MANAGER
ASSISTÊNCIAS MOTO
ORGANIZAÇÃO
GUEST
MEDIA

**PARC FERME
PARQUE FECHADO**

PARKING/PARQUE:
OFFICIAL'S
FREEPASS
VIP
MEDIA
CONVITES
AUTORIDADES

**ENTRANCE TO THE PARC FERME ON FOOT
ENTRADA NO PARQUE FECHADO A PÉ**

**PODIUM
PODIO**

**FROM / DE
NERPOR**

**TO / PARA
NERPOR**

2006

Data das imagens: 3/7/2015

39° 17.860'N

7° 25.811'O elev 460 m

altitude de visualização 1.20 km

Google earth

37ª EDIÇÃO

BAJA PORTALEGRE 2023
500

AUTOMÓVEL CLUB DE PORTUGAL



ETAPA 1 / STAGE 1
27-10-2023

Cerimónia de Partida				Quinta Feira, 26 de Outubro			
<i>Nascer do Sol - 07:59</i>				<i>Por do Sol - 18:36</i>			
CH	LOCALIZAÇÃO	SS km	Ligação km	Total km	Tempo	1ª Moto	
V4	Parque Fechado IN (Jardim do Tarro)					*	
CS0	Cerimónia de Partida						19:00
CS1	Nerpor		3,67	3,67	00:30	*	19:30
totais		0,00	3,67	3,67			

ETAPA 1				Sexta Feira, 27 outubro			
<i>Nascer do Sol - 08:00</i>				<i>Por do Sol - 18:35</i>			
CH	LOCALIZAÇÃO/Location	SS km	Ligação/Liaison km	Total km	Tempo/Time	1ª Moto/Bike	
SS1	PRÓLOGO	3,71				13:30	
1A	SS1 STOP			3,71	-	13:35	
1B	CHEGADA / ARRIVAL 1ª Etapa / Leg 1 Nerpor		6,71	6,71	02:00	*	15:35
1ª Etapa totais / totals		3,71	6,71	10,42			

ETAPA 2				Sábado, 28 outubro			
<i>Nascer do Sol - 08:01</i>				<i>Por do Sol - 18:33</i>			
CH	LOCALIZAÇÃO/Location	SS km	Ligação/Liaison km	Total km	Tempo/Time	1ª Moto/Bike	
1C	PARTIDA / START 2ª Etapa / Leg 2					10:55	
2	CH Partida SS2		77,00	77,00	01:30	12:25	
SS2	SS2	78,32				12:30	
2A	STOP SS2			78,32	-	14:00	
2B	CHEGADA / ARRIVAL 2ª Etapa / Leg 2 Nerpor		5,99	5,99	01:00	*	15:00
2ª Etapa totais / totals		78,32	82,99	161,31			

TOTAIS / TOTALS				
	SS	Ligação	Total	% SS
1ª Etapa / Leg 2 - Prólogo	3,71	6,71	10,42	35,6%
2ª Etapa / Leg 3 - SS1	78,32	82,99	161,31	48,6%
Total / Total	82,03	89,70	171,73	47,8%

* Tempo Máximo, entrada por avanço autorizada

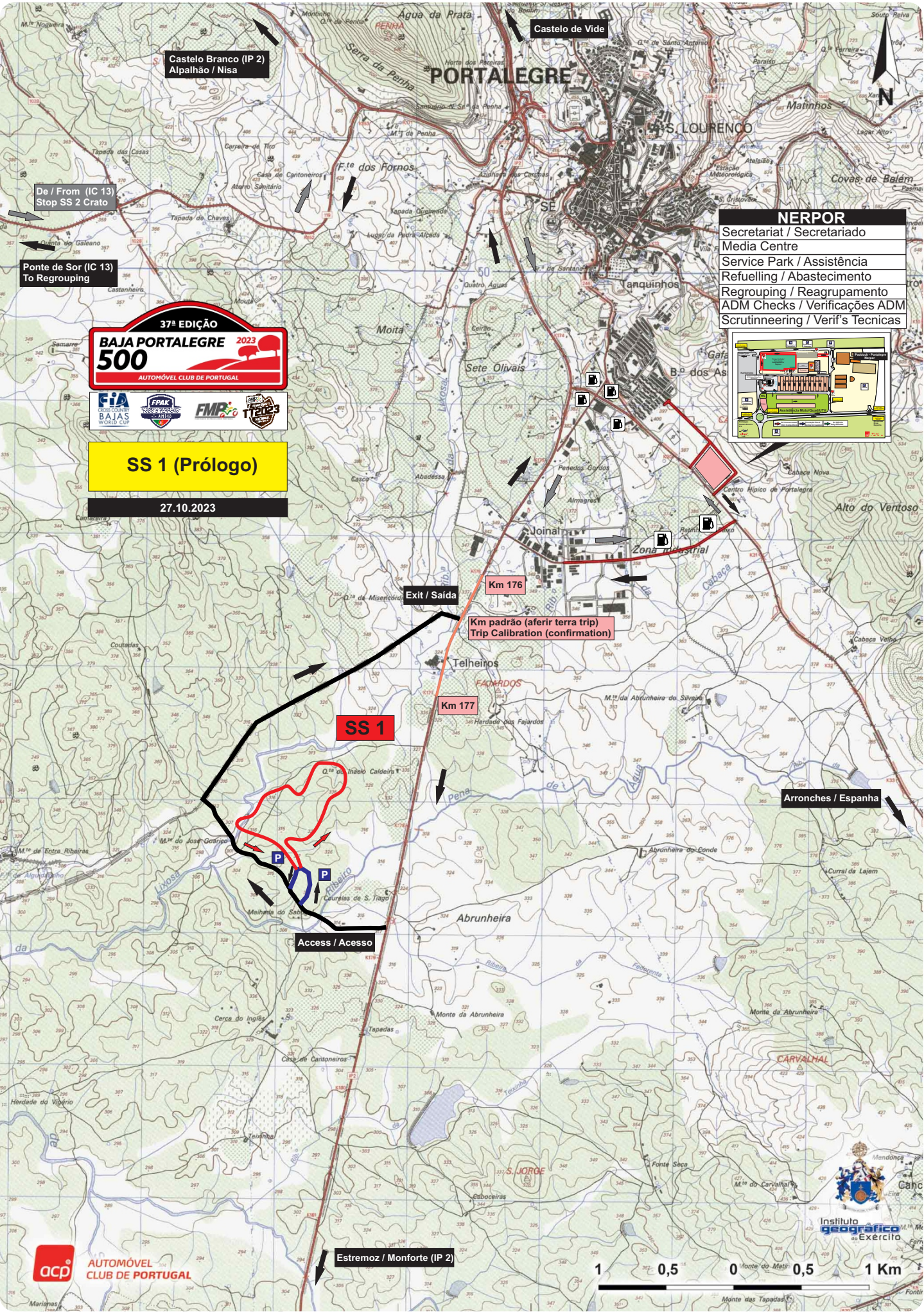

Castelo Branco (IP 2)
Alpalhão / Nisa

Castelo de Vide

PORTALEGRE

S. LOURENÇO

De / From (IC 13)
Stop SS 2 Crato

Ponte de Sor (IC 13)
To Regrouping

37ª EDIÇÃO
BAJA PORTALEGRE 2023
500
AUTOMÓVEL CLUB DE PORTUGAL

FIA
BAJAS
WORLD CUP

FFAK
SERRA DA PENHA
CROSS COUNTRY

FMR
20

TTU
2023

SS 1 (Prólogo)

27.10.2023

NERPOR

Secretariat / Secretariado
Media Centre
Service Park / Assistência
Refuelling / Abastecimento
Regrouping / Reagrupamento
ADM Checks / Verificações ADM
Scrutinneering / Verif's Técnicas

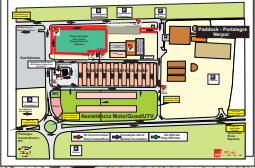

Exit / Saída

Km 176
Km padrão (aférir terra trip)
Trip Calibration (confirmation)

SS 1

Km 177

Arronches / Espanha

Access / Acesso

Estremoz / Monforte (IP 2)

acp AUTOMÓVEL CLUB DE PORTUGAL

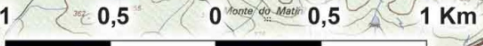

Instituto geográfico do Exército



Prólogo / SS1

27.10.2023



Saída/Exit
Para / To NERPOR/Portalegre
Para / To Ponte de Sor
Reagrupamento / Regrouping

▲ NORMAL CIRCULATION

▲ CONCORRENTES / COMPETITORS

Acesso / Access
De / From Portalegre



37ª EDIÇÃO

BAJA PORTALEGRE 2023
500

AUTOMÓVEL CLUB DE PORTUGAL



ETAPA 2 / STAGE 2

28-10-2023

Partida Mini Baja - Vale do Arco

N 39° 20.893' / W 7° 57.497'

Ponte de Sor
Portalegre

N244



N244

Gavião
Alpallão
(GAS 5 - Estação de Chança)

Google Earth

Cemitério de Vale de Arco
Parque de descarga de motos
Os pilotos devem dirigir-se para
a partida (traceljado amarelo)
Após a descarga, regressam à
EN 244 para GAS 5
(Estação de Caminho de Ferro de Chança)

Start / Partida:
SS 2 Mini Baja

28.10.2023

400 m

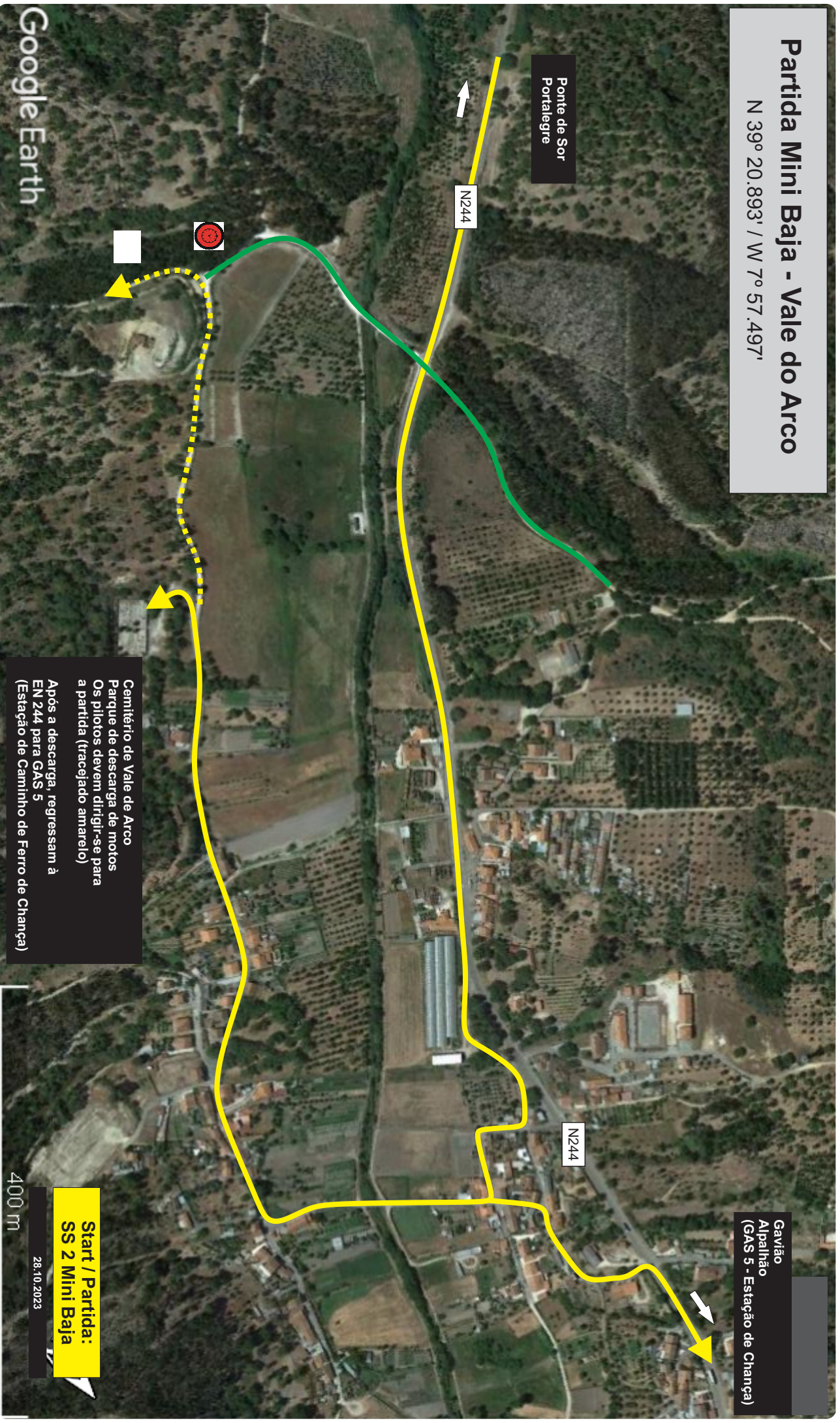

Herdade das Coutadas - Portalegre

N 39° 14.751' / W 7° 27.499'

Arrival - Chegada:
Promo Baja & Hobby
Mini Baja
SS 4 Auto

BAJA PORTALEGRE 2023
500
AUTOMÓVEL CLUB DE PORTUGAL

FIA RACING WORLD CUP
FPMK
FMP
T203

Arrival / Chegada:
Promo Baja & Hobby
Mini Baja
SS 3 Bike / Quad / SSV
SS 3 & 4 Car / Auto

28.10.2023

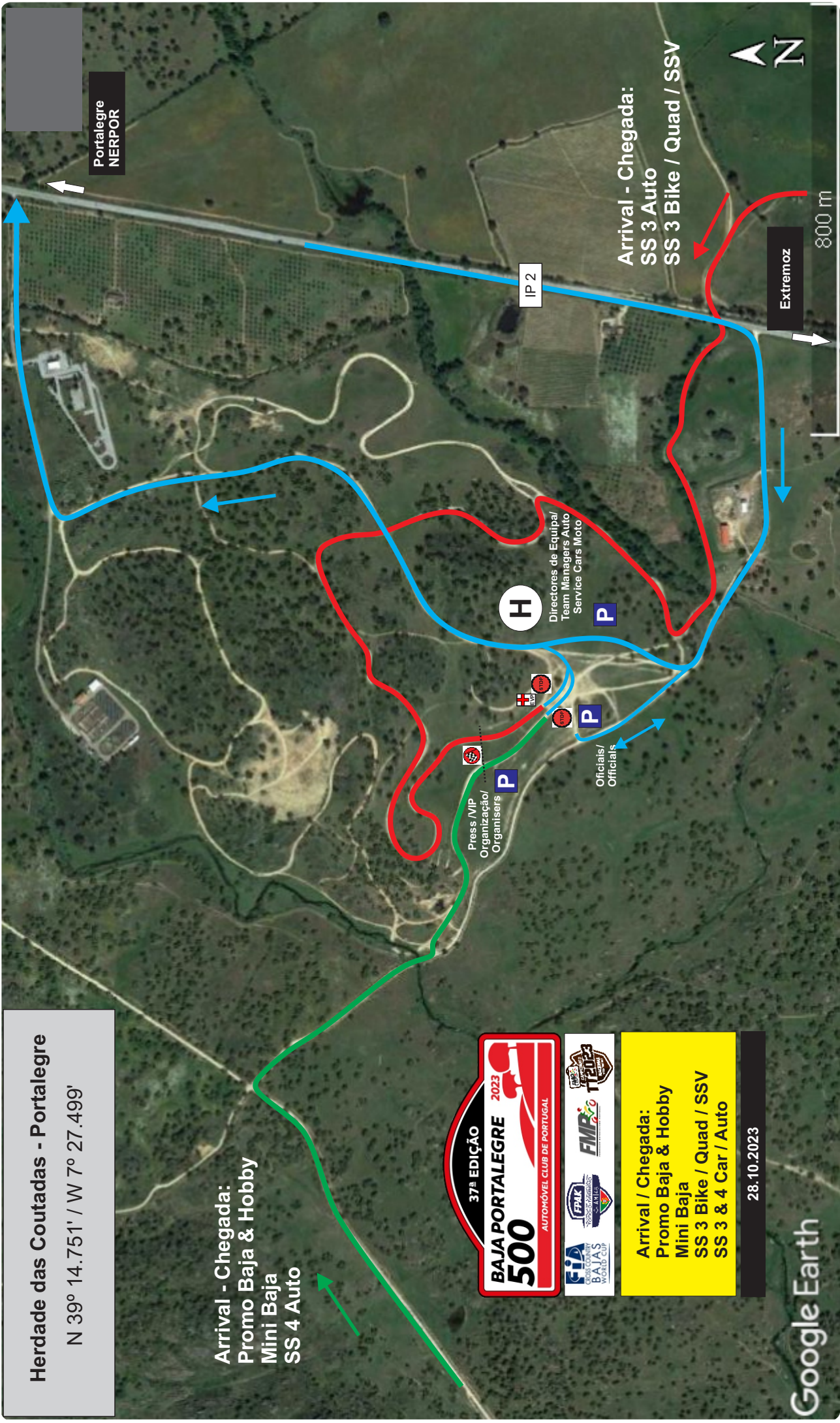

Portalegre
NERPOR

Arrival - Chegada:
SS 3 Auto
SS 3 Bike / Quad / SSV

Extremoz

800 m

H

P

P

P

P

Oficiais/
Oficiais

Press /VIP
Organização/
Organisers

Directores de Equipal
Team Managers Auto
Service Cars Moto

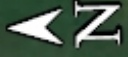

37ª EDIÇÃO

BAJA PORTALEGRE 2023
500

AUTOMÓVEL CLUB DE PORTUGAL





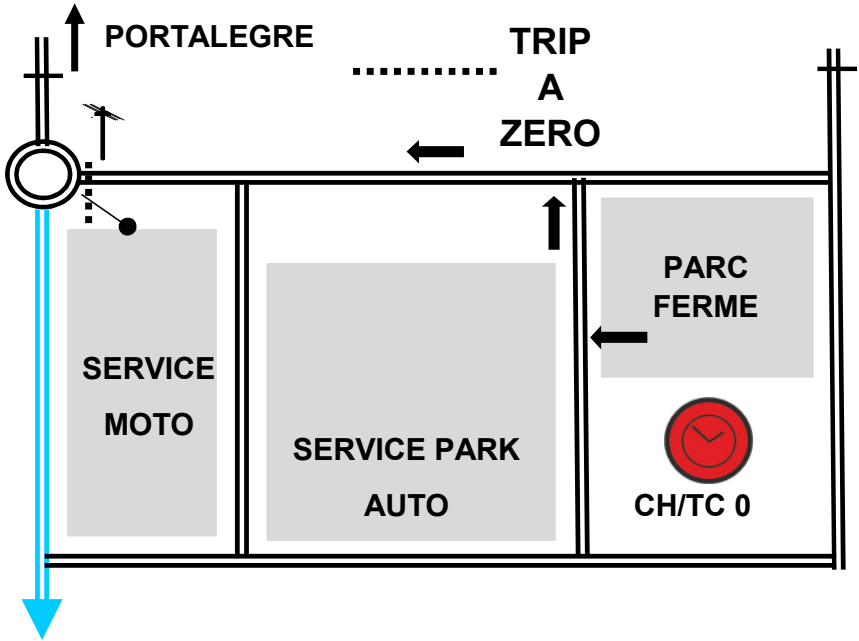
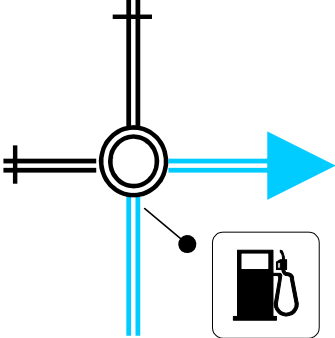
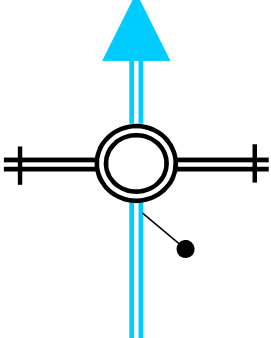
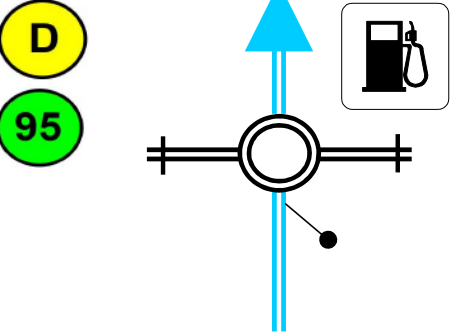

ROAD BOOK
DESENHOS GAS E ZA
27/28-10-2023

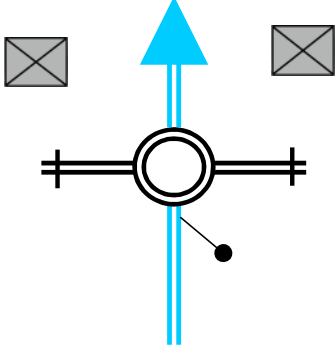
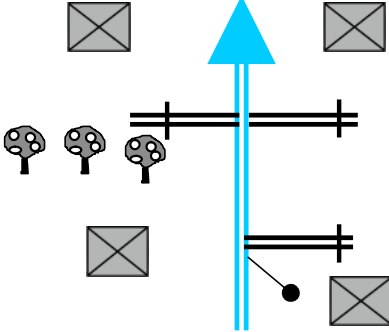
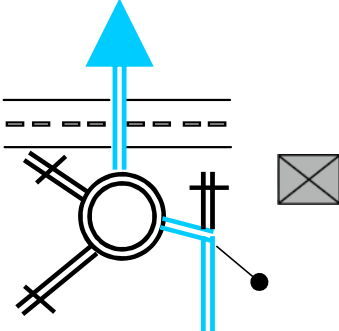
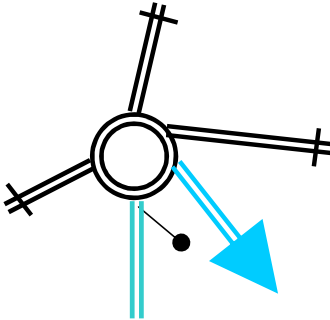
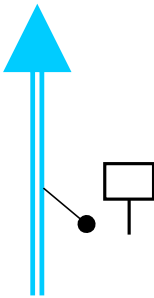

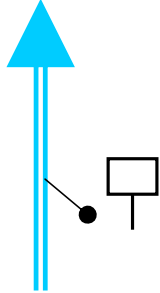
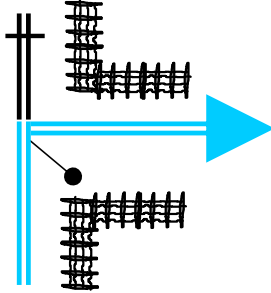
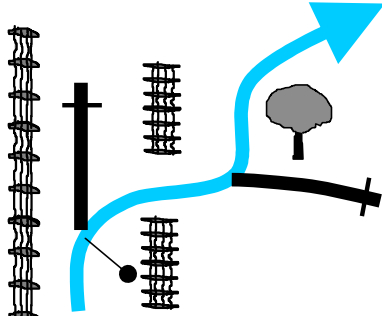

1	NERPOR - PROLOGUE	7,03 km
<p>0,00</p> <p>0,00</p>		
<p>0,76</p> <p>0,76</p>		<p>Zona Industrial</p> <p>→</p> <p>D 95</p> <p>2</p>
<p>1,07</p> <p>0,31 ↓</p>		<p>3</p>
<p>1,31</p> <p>0,24</p>		<p>ON THE RIGHT CAR WASH SELF SERVICE</p> <p>À DIREITA ESTAÇÃO DE LAVAGEM AUTO</p> <p>4</p>

NEXT 0,34

2	NERPOR - PROLOGUE	5,38 km
1,65		5
0,34		
2,14		6
0,49		
2,56		<p>Évora Monforte Escola Superior</p> <p>→</p>
0,42		7
2,91		<p>Évora Monforte</p> <p>→</p>
0,35		8
3,45		<p><u>IP2 KM 176</u></p> <p>TRIP CALIBRATION</p> <p>MEDIDA PADRÃO</p>
0,54		9

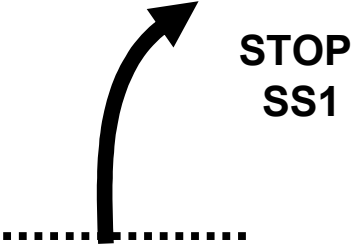
NEXT 1,00

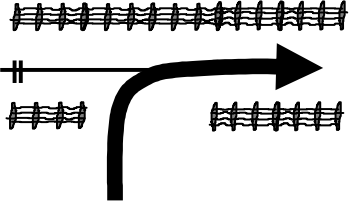
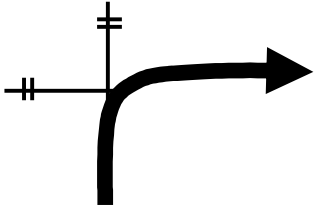
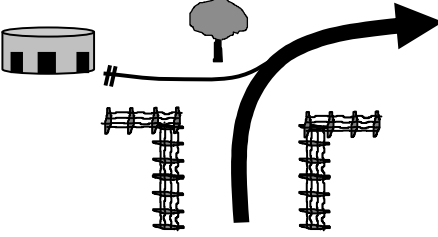
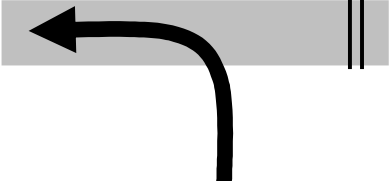
3	NERPOR - PROLOGUE	2,58 km
<p data-bbox="172 275 400 405">4,45</p> <p data-bbox="89 465 252 566">1,00</p>		<p data-bbox="1169 264 1401 309"><u>IP2 KM 177</u></p> <p data-bbox="1177 342 1409 427">TRIP CALIBRATION</p> <p data-bbox="1150 472 1441 510">MEDIDA PADRÃO</p> <p data-bbox="1401 510 1441 555">10</p>
<p data-bbox="172 633 395 763">6,20</p> <p data-bbox="89 824 252 925">1,75</p>		<p data-bbox="1137 633 1449 741">Q^TRO</p> <p data-bbox="1169 763 1417 808">(IP2 KM 178,8)</p> <p data-bbox="1401 869 1441 913">11</p>
<p data-bbox="172 992 395 1122">6,88</p> <p data-bbox="89 1182 252 1283">0,68</p>		<p data-bbox="1209 1059 1369 1115">START</p>  <p data-bbox="1401 1227 1441 1272">12</p>
<p data-bbox="172 1350 395 1480">7,03</p> <p data-bbox="89 1541 252 1641">0,15</p>		 <p data-bbox="1225 1608 1345 1641">CH/TC 1</p> <p data-bbox="1401 1585 1441 1630">13</p>

PAGE 1	SS1 / PORTALEGRE (NERPOR)		
1	<p>0,00</p> <p>0,00</p>		<p>TRIP A ZERO</p>  <p>CH/TC 1A</p>
2	<p>0,13</p> <p>0,13</p>		
3	<p>1,15</p> <p>1,02</p>		
4	<p>3,47</p> <p>2,32</p>		
5	<p>3,62</p> <p>0,15</p>	<p>(IP 2)</p> 	

PROXIMA NOTA
PROCH.NOTE
NEXT NOTE

0,48

4,10

0,48

6

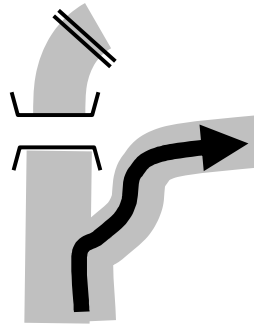

~~IP2~~
Portalegre

Zona Industrial

escolas

4,32

0,22

7

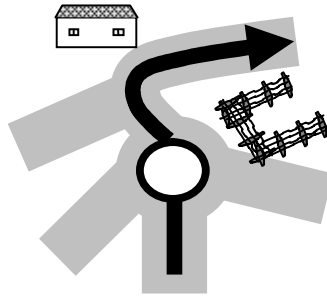

IPO

zona industrial

centro de formação

4,77

0,45

8

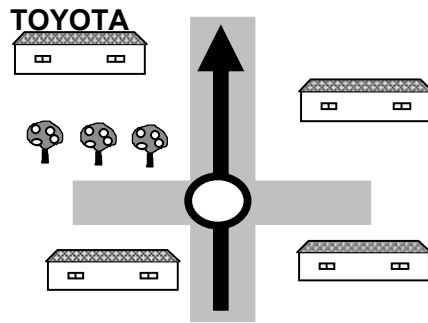

5,28

0,51

9

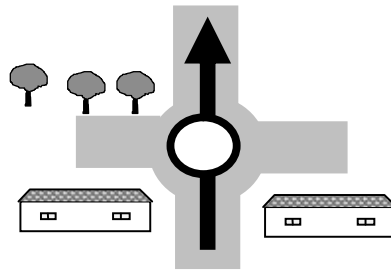

5,62

0,34

10

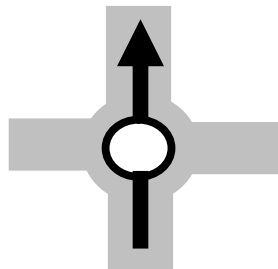

À ESQUERDA
ESTAÇÃO DE
LAVAGEM AUTO

ON THE LEFT CAR
WASH SELF SERVICE

5,87

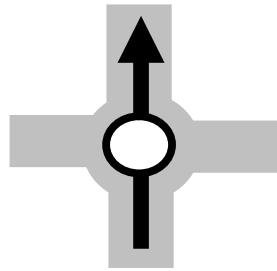

11

0,25

6,20

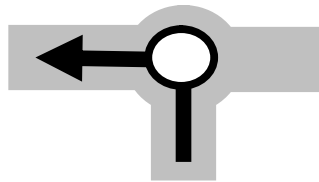

12





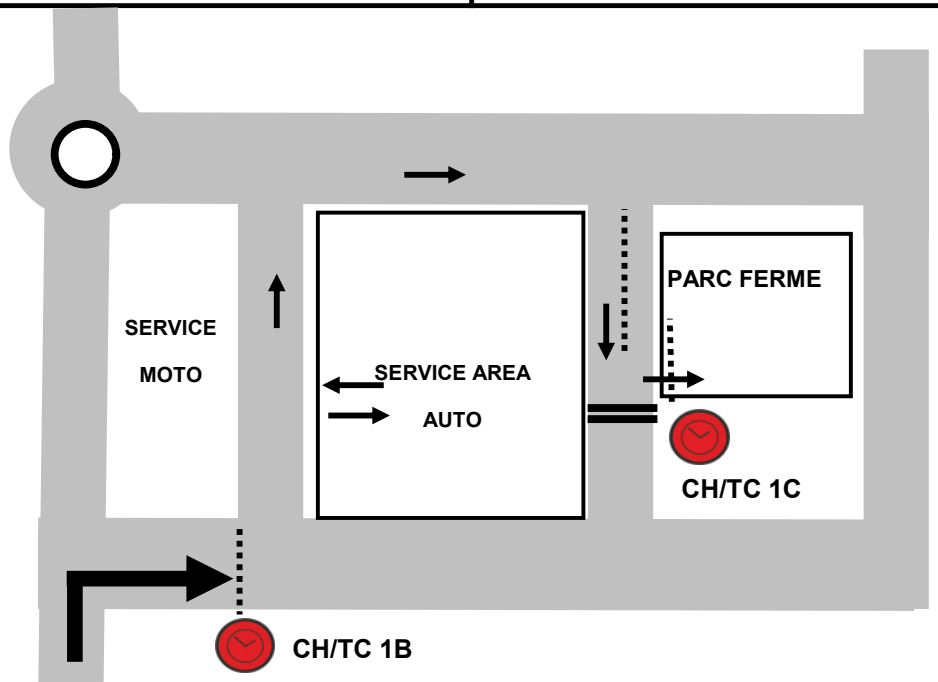

0,33

6,71

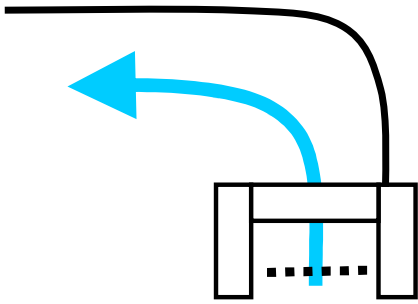

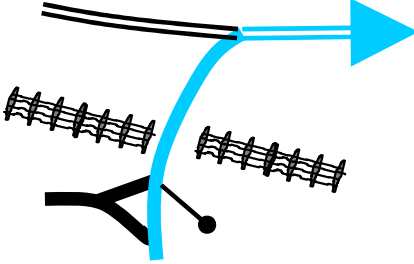
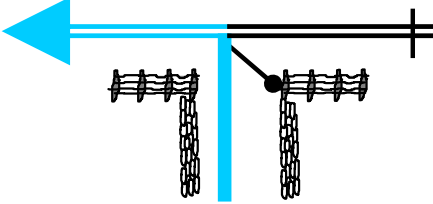

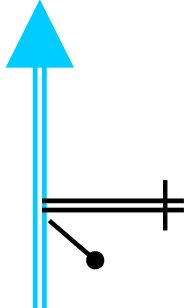
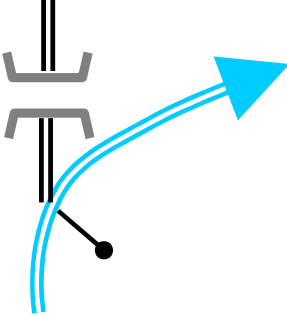

13

0,51

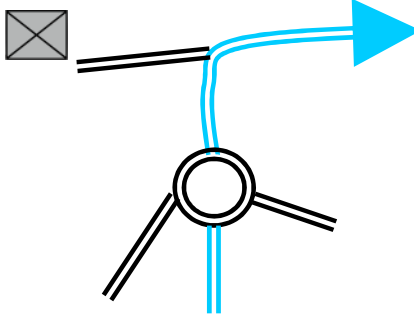
1	ARRIVAL SS2 - NERPOR	5,99 km
0,00		 CH/TC 2A 1
0,00		
1,20		RO 2
1,20		
1,80		 3
0,60		
2,72		4
0,92		
3,36		IP2 PORTALEGRE POLITECNICO ZONA INDUSTRIAL  5
0,64		

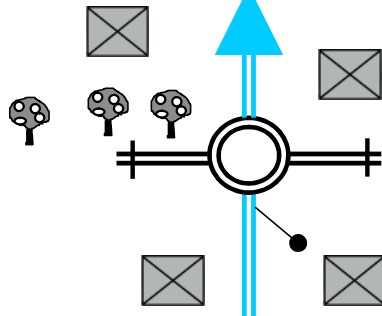
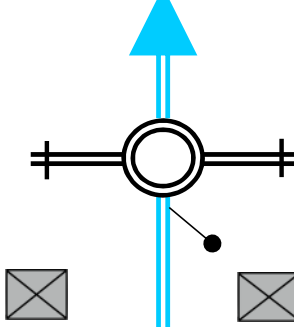
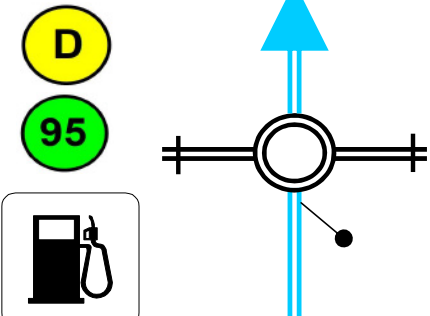
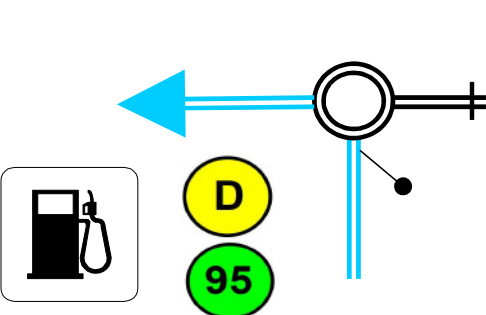
NEXT 0,16

2	ARRIVAL SS2 - NERPOR	2,47 km
<p style="background-color: #00FF00; color: black; padding: 10px; font-size: 24px; text-align: center;">3,52</p> <p style="background-color: #00FF00; color: black; padding: 5px; font-size: 18px; text-align: center;">0,16</p>		<p>ZONA INDUSTRIAL CENTRO INSPEÇÕES</p>  <div style="border: 1px solid black; width: 20px; height: 20px; text-align: center; line-height: 20px; margin-left: auto;">6</div>
<p style="font-size: 24px; text-align: center;">3,98</p> <p style="border: 1px solid black; padding: 5px; font-size: 18px; text-align: center;">0,46</p>		<div style="border: 1px solid black; width: 20px; height: 20px; text-align: center; line-height: 20px; margin-left: auto;">7</div>
<p style="font-size: 24px; text-align: center;">4,48</p> <p style="border: 1px solid black; padding: 5px; font-size: 18px; text-align: center;">0,50</p>		<div style="border: 1px solid black; width: 20px; height: 20px; text-align: center; line-height: 20px; margin-left: auto;">8</div>
<p style="font-size: 24px; text-align: center;">4,82</p> <p style="border: 1px solid black; padding: 5px; font-size: 18px; text-align: center;">0,34</p>		<p>À ESQUERDA ESTAÇÃO DE LAVAGEM AUTO</p> <p>ON THE LEFT CAR WASH SELF SERVICE</p> <div style="border: 1px solid black; width: 20px; height: 20px; text-align: center; line-height: 20px; margin-left: auto;">9</div>
<p style="font-size: 24px; text-align: center;">5,40</p> <p style="border: 1px solid black; padding: 5px; font-size: 18px; text-align: center;">0,58</p>		<p>ELVAS ARRONCHES C.po MAIOR ESPANHA</p>  <div style="border: 1px solid black; width: 20px; height: 20px; text-align: center; line-height: 20px; margin-left: auto;">11</div>

NEXT 0,59

3

ARRIVAL SS2 - NERPOR

0,59 km

5,99

0,59

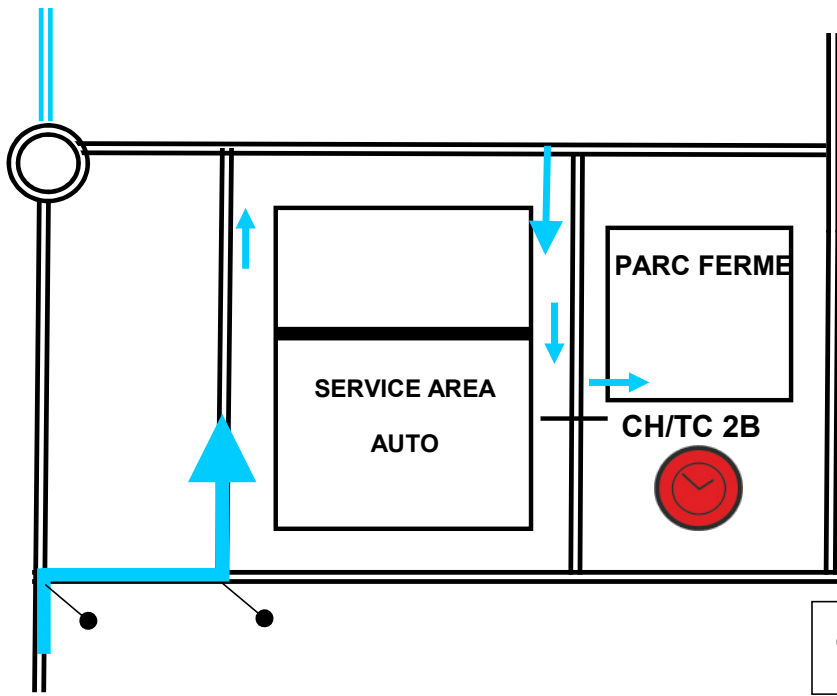

12

GAS 5 - ESTAÇÃO DE CHANÇA

N 39° 16.445' / W 7° 48.499'

De / From
Sume / Cunheira



GAS 5 - Estação Chança
Mini Baja

28.10.2023

Para / To
Vale de Açor
Portalegre (IC 13)

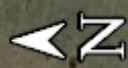

300 m

- Percurso Assistências / Service car liaison
- Percurso Concorrentes / SS race
- Espaço de Assistência / Service area

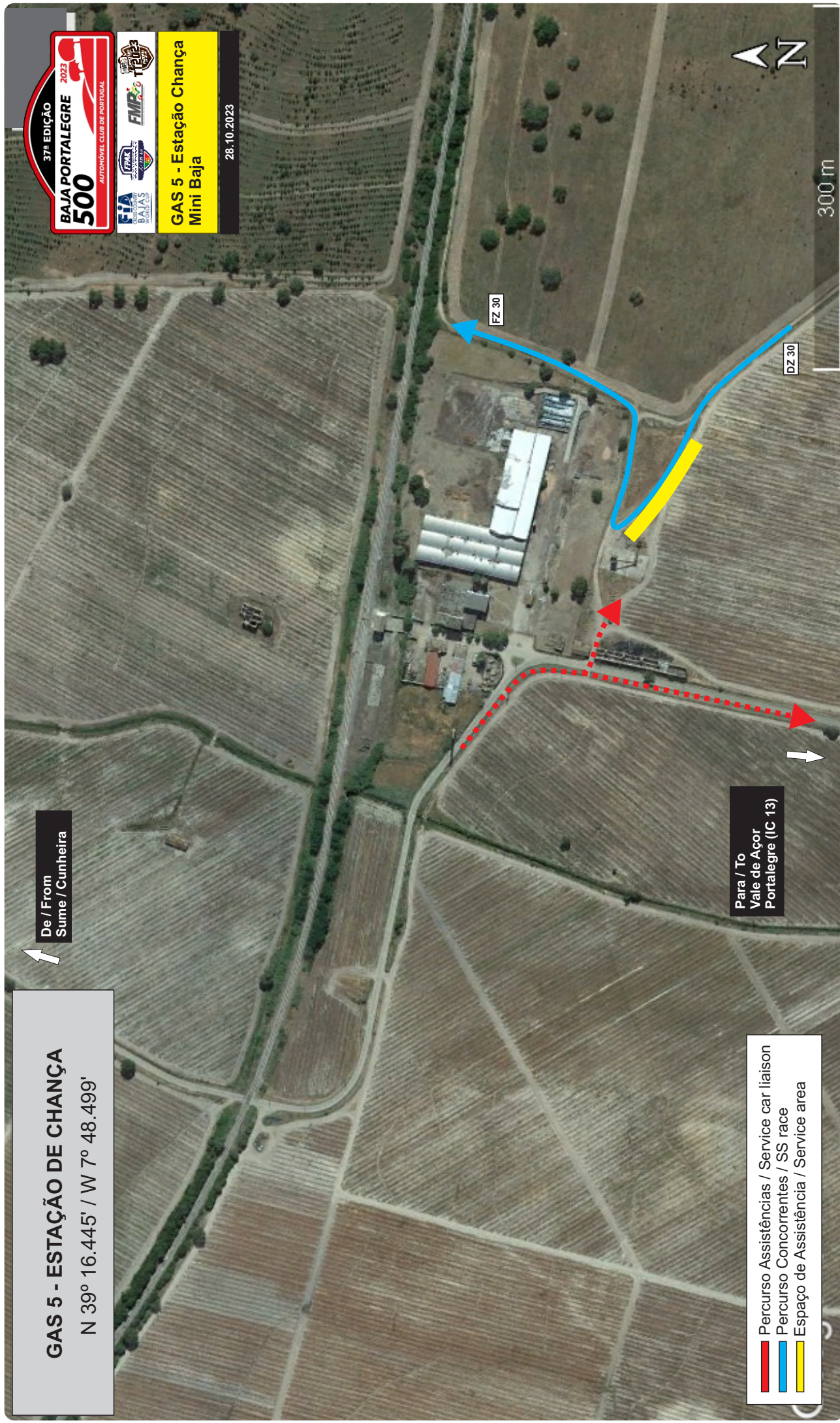







ASSISTÊNCIA MINI BAJA

Total Kms 184,31

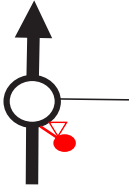
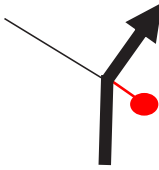
Distance		Direction	Information
Total	Partial		
NERPOR - START SS 2			
0,00	0,00	 NERPOR	
0,53	0,53		
0,86	0,33		
1,11	0,25		
3,26	2,15		
3,40	0,14		
5,19	1,79		

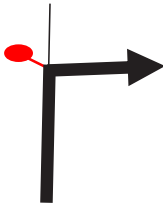

ASSISTÊNCIA MINI BAJA

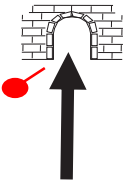
Total Kms 184,31

	Distance		Direction	Information
	Total	Partial		
8	6,23	1,04		<div style="border: 1px solid black; padding: 2px; display: inline-block; margin-bottom: 5px;">Frangoneiro</div> <div style="border: 1px solid black; padding: 2px; display: inline-block; margin-bottom: 5px;">P. Sôr</div> <div style="border: 1px solid black; padding: 2px; display: inline-block;">Crato</div>
9	39,07	32,84		<div style="border: 1px solid black; padding: 2px; display: inline-block; margin-bottom: 5px;">Benavila</div> <div style="border: 1px solid black; padding: 2px; display: inline-block;">Avis Seda</div>
10	62,96	23,89		
11	63,28	0,32	 Ponte de Sôr	<div style="border: 1px solid black; padding: 2px; display: inline-block;">C. Branco Gavião</div>
12	63,87	0,59	 Ponte de Sôr	
13	64,96	1,09		
14	65,51	0,55		

ASSISTÊNCIA MINI BAJA

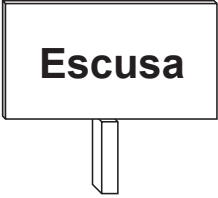
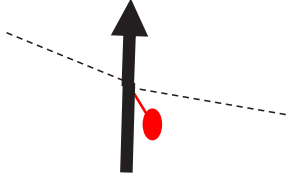

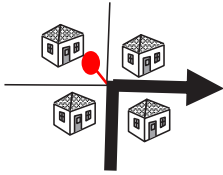
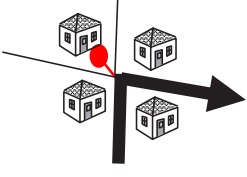
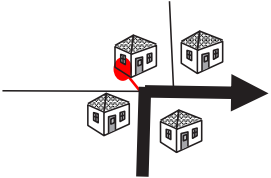
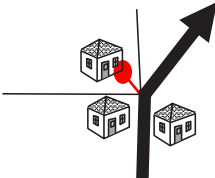
Total Kms 184,31

	Distance		Direction	Information
	Total	Partial		
15	73,83	8,32		
16	76,77	2,94		
17	77,41	0,64		
18	77,60	0,19		
19	77,71	0,11		
20	77,94	0,23		
21	78,10	0,16		

ASSISTÊNCIA MINI BAJA

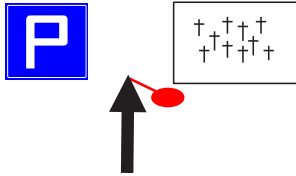

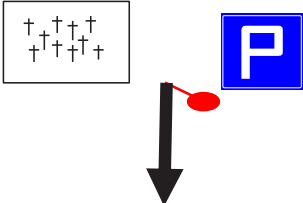
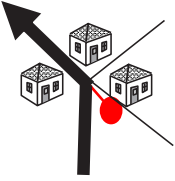
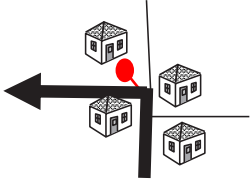
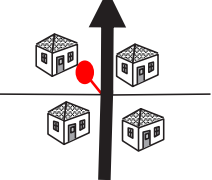
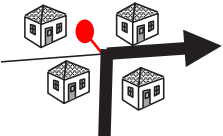
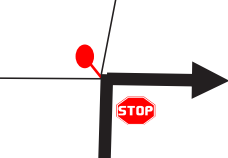
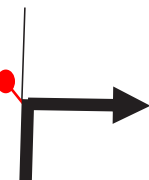

Total Kms 184,31

	Distance		Direction	Information
	Total	Partial		
22	78,58	0,48		
23	78,66	0,08		<p>Parque de descarga das motos para a Partida Mini Baja Vale do Arco</p>

Distance		Direction	Information
Total	Partial		
START SS 2 - GAS 5 (ESTAÇÃO DE CHANÇA)			
0,00	0,00		Retome o percurso em sentido inverso
0,55	0,55	 <p>Vale do Arco</p>	
0,71	0,16	 <p>Vale do Arco</p>	
0,95	0,24	 <p>Vale do Arco</p>	
1,00	0,05	 <p>Vale do Arco</p>	
1,16	0,16	 <p>Vale do Arco</p>	
4,45	3,29	 <p>São Bartolomeu</p>	

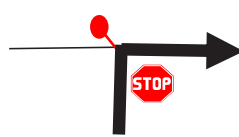
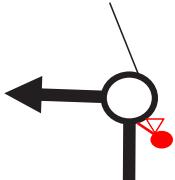
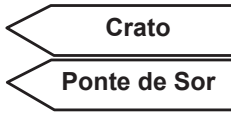
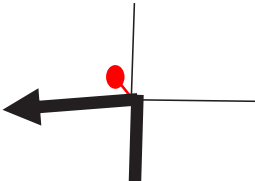
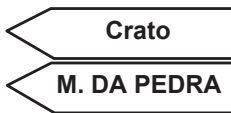
ASSISTÊNCIA MINI BAJA

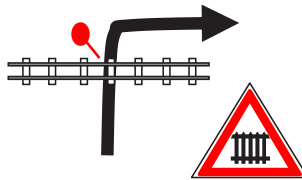
Total Kms 184,31

	Distance		Direction	Information
	Total	Partial		
31	7,55	3,10	 Vale de Gaviões	
32	7,76	0,21	 Vale de Gaviões	
33	11,69	3,93	 Monte dos Pereiros	
34	13,46	1,77	 Sume	
35	20,67	7,21	 Cunheira	
36	20,84	0,17		
37	22,18	1,34	 Cunheira	

ASSISTÊNCIA MINI BAJA

Total Kms 184,31

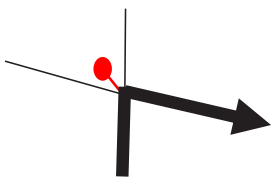
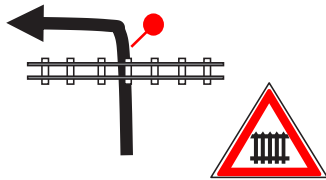
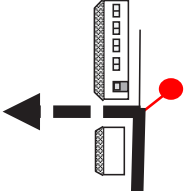



	Distance		Direction	Information
	Total	Partial		
38	22,32	0,14	 Cunheira	
39	27,82	5,50		
40	28,36	0,54		<p>GAS 5 Estação de Chança</p>

	Distance		Direction	Information
	Total	Partial		
GAS 5 (ESTAÇÃO DE CHANÇA) - STOP SS 2				
41	0,00	0,00		Retome o percurso no mesmo sentido
42	3,27	3,27	 Chancelaria	
43	6,90	3,63		
44	11,92	5,02		
45	28,49	16,57		
46	33,62	5,13		
47	61,22	27,60		

ASSISTÊNCIA MINI BAJA

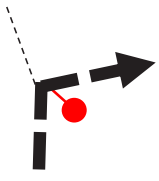
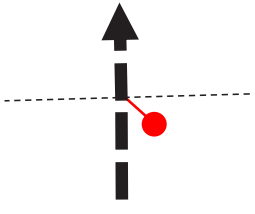
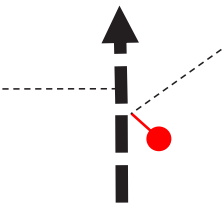
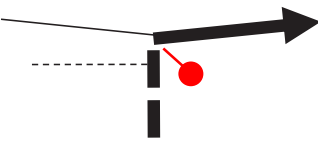
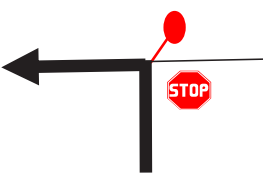
Total Kms 184,31

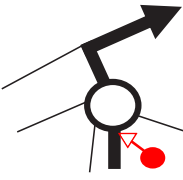
	Distance		Direction	Information
	Total	Partial		
48	62,24	1,02		<div style="border: 1px solid black; padding: 2px; margin-bottom: 2px;">Portalegre</div> <div style="background-color: green; color: white; padding: 2px; margin-bottom: 2px;">IP2 Évora</div> <div style="border: 1px solid black; padding: 2px;">Elvas</div>
49	63,74	1,50		<div style="background-color: green; color: white; padding: 2px; margin-bottom: 2px;">Évora</div> <div style="background-color: green; color: white; padding: 2px; margin-bottom: 2px;">Elvas</div> <div style="background-color: green; color: white; padding: 2px; margin-bottom: 2px;">ESPANHA</div> <div style="background-color: gray; color: white; padding: 2px;">zona industrial</div>
50	66,00	2,26		<div style="border: 1px solid black; padding: 2px; margin-bottom: 2px;">Elvas Arronches</div> <div style="border: 1px solid black; padding: 2px; margin-bottom: 2px;">ESPANHA</div> <div style="border: 1px solid black; padding: 2px;">Portalegre</div>
51	67,17	1,17		<div style="background-color: gray; color: white; padding: 2px; margin-bottom: 2px;">zona industrial</div> <div style="border: 1px solid black; padding: 2px; margin-bottom: 2px;">politécnico</div> <div style="border: 1px solid black; padding: 2px;">centro inspeções</div>
52	70,34	3,17		(Terra / Gravel)
53	71,03	0,69		FINAL

Distance		Direction	Information
Total	Partial		
STOP SS 2 - NERPOR			
54	0,00		FINAL
55	0,67		
56	1,07		
57	1,38		(Asfalto / Asphalt Road)
58	2,92		
59	3,47		
60	3,63		

ASSISTÊNCIA MINI BAJA

Total Kms 184,31

	Distance		Direction	Information
	Total	Partial		
61	4,59	0,96		
62	4,93	0,34		
63	5,18	0,25		
64	5,51	0,33		<div style="border: 1px solid black; padding: 5px; display: inline-block; margin-bottom: 10px;">Elvas Arronches</div> <div style="border: 1px solid black; padding: 5px; display: inline-block;">Portalegre</div>
65	6,26	0,75		NERPOR

Segurança dos Espectadores Spectator Safety

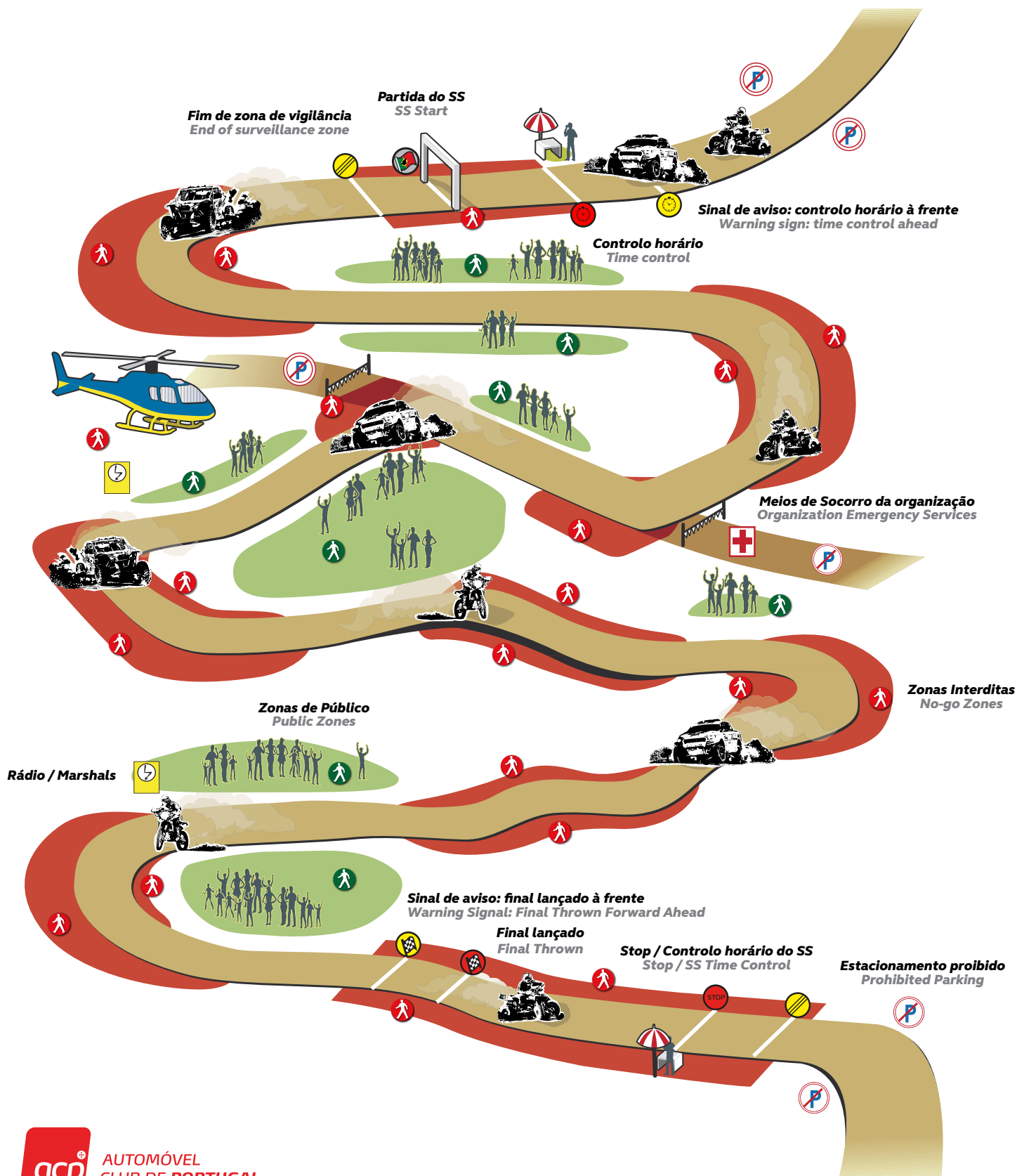

bp
ultimate
com tecnologia
ACTIVE

